

- ① FINISH GRADE
- ② K-RAIN MINIPRO GEAR DRIVE ROTOR MODEL 13003: 4" POP-UP ROTOR
- ③ 1/2" RIGID SWING JOINT: SCHEDULE 80 NIPPLE, SCHEDULE 40 STREET ELLS
- ④ LATERAL TEE OR ELL
- ⑤ LATERAL PIPE

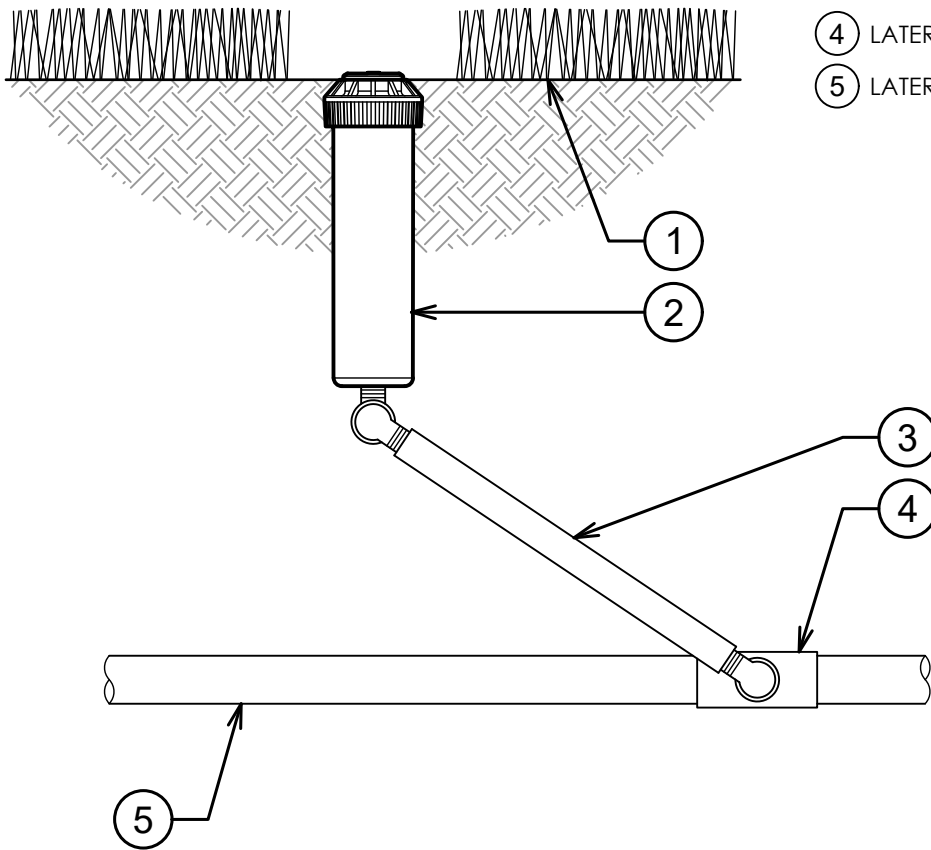

K-RAIN MINIPRO ROTOR WITH 4" POP-UP

3" = 1'-0"